

# U1000MKII Pipe Mount

U1000MKII-FM: Clamp-on Ultrasonic Flow Meter

U1000MKII-HM: Clamp-on Ultrasonic Heat Meter

## User Manual



Micronics Ltd, Knaves Beech Business Centre,  
Davies Way, Loudwater, High Wycombe, Bucks HP10 9QR

**Telephone:** +44(0)1628 810456    **E-mail:** [sales@micronicsltd.co.uk](mailto:sales@micronicsltd.co.uk)

[www.micronicsflowmeters.com](http://www.micronicsflowmeters.com)

## DOCUMENT AUTHORITY

<b>Issue</b>	3.4			
<b>Originator</b>	Micronics Ltd			
<b>Checked</b>				
<b>Approved</b>				
<b>Date</b>	13/12/2022			

# CONTENTS

<b>1</b>	<b>INTRODUCTION</b>	<b>1</b>
1.1	General Description	1
1.2	How Does It Work?	2
1.3	Package Contents	3
1.4	Display	4
<b>2</b>	<b>INSTALLATION</b>	<b>5</b>
2.1	Identify Suitable Location	5
2.1.1	Additional Considerations for Locating U1000MkII-HM	5
2.1.2	Clean the Pipe's Flow Sensor Contact Area	6
2.2	Connect Power and Signal Cables	6
2.2.1	Power Supply	6
2.2.2	Pulse Output Connection	7
2.2.3	Current Output	7
2.3	Switch On	8
2.3.1	U1000MkII-FM	8
2.3.2	U1000MkII-HM	10
2.4	Adjust Flow Sensor Separation	12
2.5	Apply Gel Pads	12
2.6	Clamp Sensor Assembly to Pipe	12
2.6.1	Pipe Adaptors	13
2.6.2	Attaching to Pipe	13
2.7	Remove Sensor-Holding Screws	14
2.8	Connect Electronics Module	15
2.9	Attach the Temperature Sensors (U1000MkII-HM Only)	15
2.9.1	To ensure an accurate temperature differential:	15
2.10	Clip Electronics Module to Sensor Assembly	16
2.11	Setting Zero Flow	16
<b>3</b>	<b>MENU STRUCTURES</b>	<b>18</b>
3.1	Accessing the Menus	18
3.2	Setup Menu Metric	19
3.3	Setup Menu Imperial	20
3.4	Volume Total Menu	21
3.5	Current Output Menu	21
3.6	Pulse Output Menu	22
3.7	Calibration Menu	23
3.8	Diagnostics Menu	24
<b>4</b>	<b>OUTPUTS</b>	<b>25</b>

4.1	Pulse Output.....	25
4.1.1	Volumetric Pulse.....	25
4.1.2	Frequency Mode.....	25
4.1.3	Energy Pulse (U1000MkII-HM only).....	26
4.1.4	Flow Alarm - Low Flow .....	26
4.1.5	Flow Alarm – Signal Loss .....	26
4.2	4–20 mA Current Output.....	26
<b>5</b>	<b>CALIBRATION .....</b>	<b>27</b>
<b>6</b>	<b>RELOCATING THE UNIT.....</b>	<b>28</b>
<b>7</b>	<b>TROUBLESHOOTING THE INSTALLATION.....</b>	<b>29</b>
7.1	Incorrect pipe data .....	29
7.2	Sensor not in contact with the pipe .....	29
7.3	Air in the liquid/pipe .....	29
7.4	No Gel pad or grease on the sensor .....	29
7.5	Very poor pipe condition-surface/inside .....	29
7.6	Positioning.....	29
7.7	Flow reading when the system is closed.....	31
7.8	No flow reading visible when the system is active.....	31
7.9	Limitations with galvanised pipe.....	31
7.10	Limitations with Mixtures.....	31
7.10.1	Glycol / Water mixes.....	31
7.10.2	Ethanol Water mixes.....	31
7.10.3	Additives.....	31
7.11	Limitations with composite pipes.....	31
<b>8</b>	<b>APPENDIX.....</b>	<b>32</b>
8.1	Specification .....	32
8.2	Default values.....	34
8.2.1	Data Entry Errors.....	35
	Figure 1 : Principle of Operation .....	2
	Figure 2 : Typical Package Contents .....	3
	Figure 3 : Display.....	4
	Figure 4 : Location of U1000.....	5
	Figure 5 : Location with Temperature Probes .....	5
	Figure 6 : Cable Wiring Assignment.....	6
	Figure 7 : Attach Electronics Module.....	16
	Figure 8 : Sensor Positioning.....	30

# 1 INTRODUCTION

## 1.1 General Description

This manual describes the installation and use of the two models in the U1000MkII range:

- **U1000MkII-FM** is an ultrasonic clamp-on flow meter for measuring flow rate and total flow with a volume pulse output and optional Modbus, M-Bus or 4-20mA flow proportional output. It can be used as a standalone meter or as part of an integral management system.
- **U1000MkII-HM** is an ultrasonic clamp-on thermal, heat/energy meter. It uses ultrasound to measure flow rate and is also equipped with PT100 temperature sensors to measure flow and return temperatures. The U1000MKII-HM displays energy rate and totalised energy with pulse output and communication options, so it can be used as a standalone meter or as an integral part of Automatic Monitoring & Targeting (aM&T) or a Building Energy Management System (BEMS).

## 1.2 How Does It Work?

The U1000MKII uses a cross correlation transit time algorithm to provide accurate flow measurements.

An ultrasonic beam of a given frequency is generated by applying a repetitive voltage pulse to the transducer crystals. This transmission goes first from the downstream transducer to the upstream transducer as shown in the upper half of Figure 1. The transmission is then made in the reverse direction, being sent from the upstream transducer to the downstream transducer as shown in the lower half of Figure 1. The speed at which the ultrasound is transmitted through the liquid is accelerated slightly by the velocity of the liquid through the pipe. The subsequent time difference  $T1 - T2$  is directly proportional to the liquid flow velocity.

With HM models, two temperature sensors measure the difference in temperature between the flow and return of the flow system being monitored. The temperature difference, in combination with the volume of water that has flowed through the system, is then used to calculate the energy transferred to or from the water.

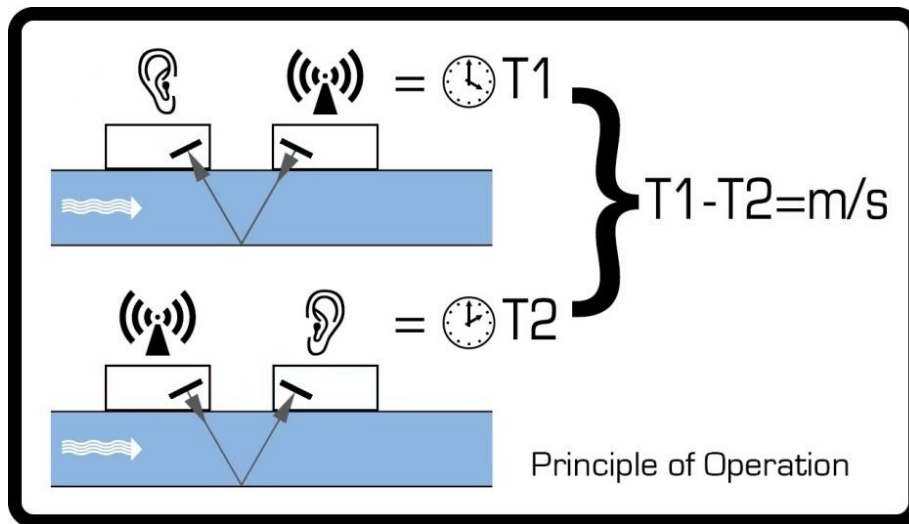

Figure 1 : Principle of Operation

### 1.3 Package Contents

The unit consists of two parts:

1. **Electronics Module**  
Consisting of the keypad and display, power, signal and comms connections. The Electronics Module clips onto the Sensor Assembly.
2. **Sensor Assembly**  
Incorporating guide rails and two transducers for flow measurement.

In addition, the kit contains:

3. Adhesive gel pads (4).
4. 2-part adaptors for fixing sensor assembly to pipes with an OD less than 60mm (2)
5. Quick release clamps for use with pipes with an OD of 51-127mm (2)
6. Quick release clamps for use with pipes with an OD of 25-70mm (2)
7. *U1000MkII-HM only*: non-releasable stainless cable ties for temperature sensors (2).
8. *U1000MkII-HM only*: PT100 temperature sensors with 3m cable (2).
9. Modbus/M-Bus cable (as needed).



Figure 2 : Typical Package Contents

## 1.4 Display

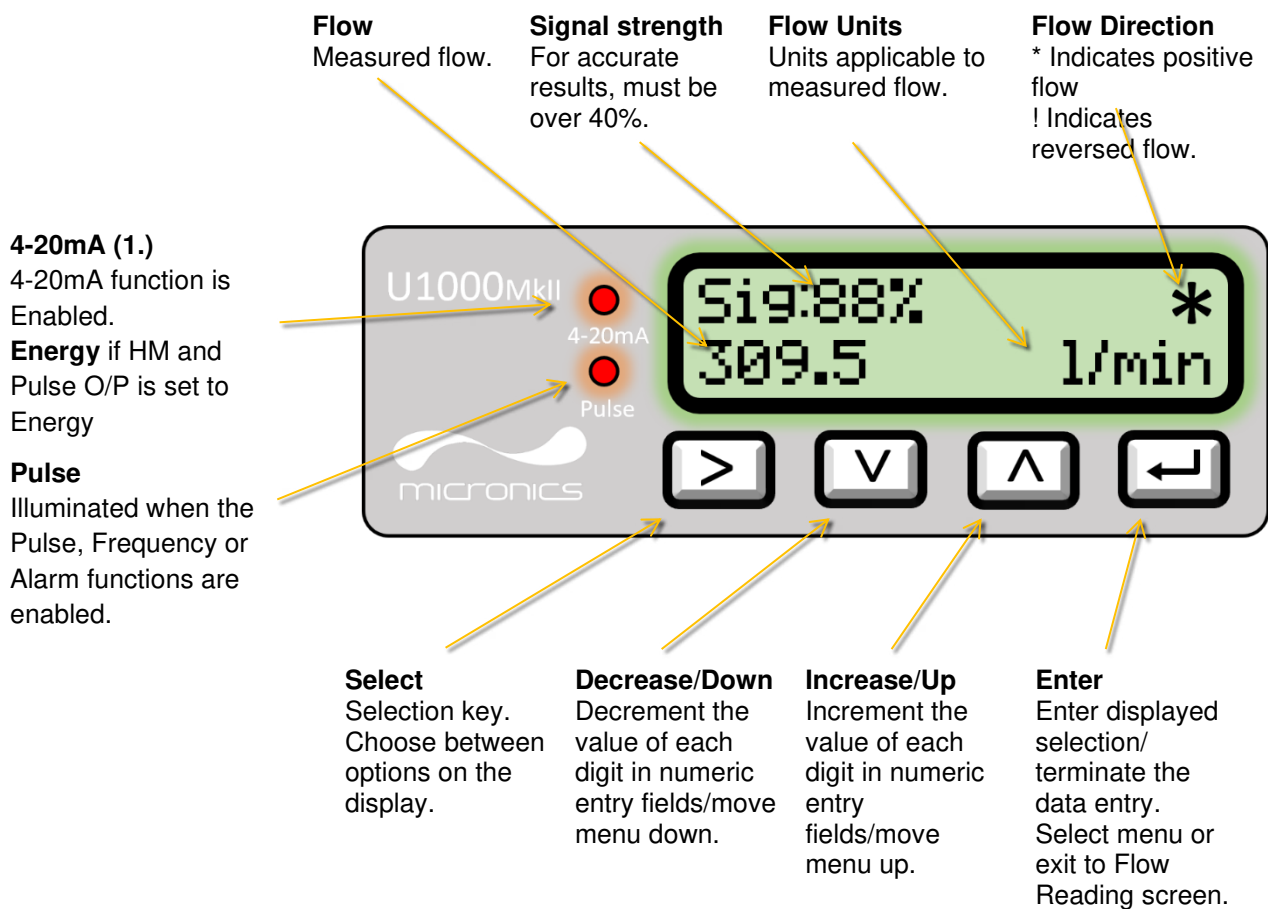

Figure 3 : Display

1. For a HM the front panel will indicate “**Energy**” for the Top Led. Illuminates if Pulse O/P is on and set to energy (not flow).



## 2 INSTALLATION

### 2.1 Identify Suitable Location

We recommend a location where there is a straight length of pipe with no bends, constrictions, or obstructions within at least 10 times the pipe diameter upstream, and 5 times the pipe diameter downstream.

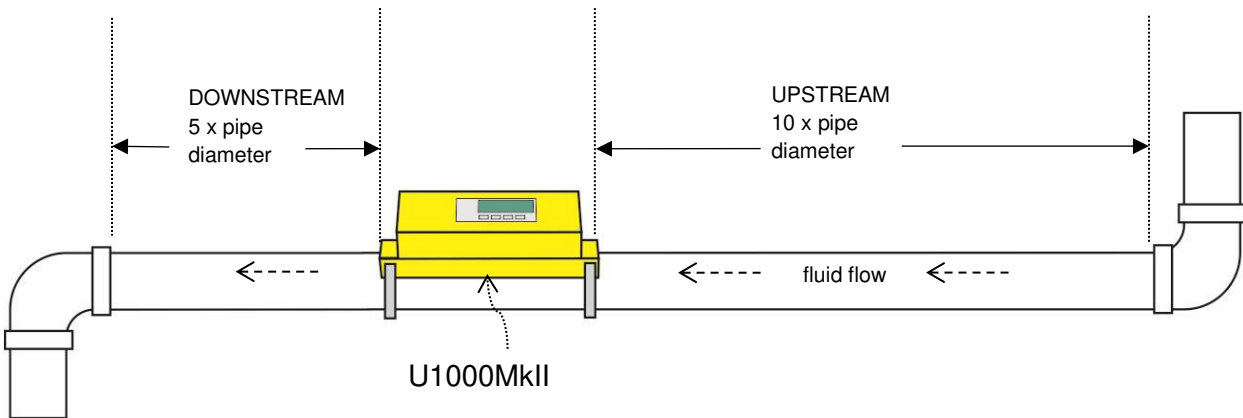

Figure 4 : Location of U1000

**Important: Do not expect to obtain accurate results if the unit is positioned close to any obstruction that distorts the uniformity of the fluid flow profile. Micronics Ltd accepts no responsibility or liability if product has not been installed in accordance with these instructions.**

#### 2.1.1 Additional Considerations for Locating U1000MkII-HM

For optimum reliability on boiler applications, the flow measurement needs to be made on the cold side of the system. For optimum reliability in chiller applications, the flow measurement needs to be made on the warmer side of the system.

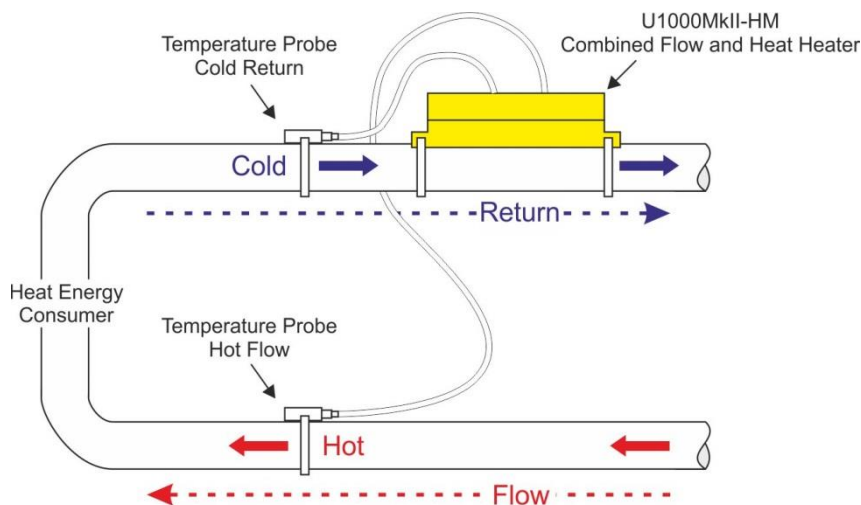

Figure 5 : Location with Temperature Probes

### 2.1.2 Clean the Pipe's Flow Sensor Contact Area

Prepare the pipe by removing any paint and degreasing the area to be installed to obtain the best possible surface. A smooth contact between pipe surface and the face of the sensors is an important factor in achieving a good ultrasound signal strength and therefore maximum accuracy.

*U1000MKII-HM*: The area of pipe where the temperature sensors are to be attached must be free of grease and any insulating material. It is recommended that any coating on the pipe is removed so that the sensor has the best possible thermal contact with the pipe.

## 2.2 Connect Power and Signal Cables

This section explains how to connect power and signal cables to the Electronics Module.

### 2.2.1 Power Supply

The U1000MKII will operate within the voltage range 12–24 VDC/24 VAC. The supply must have a minimum rating of 7 W/7 VA per instrument.

External power supply must be class 2 rated.



**Important: It is the responsibility of the installer to conform to the regional voltage safety directives when connecting the U1000MKii to a power supply using a mains-rated transformer.**

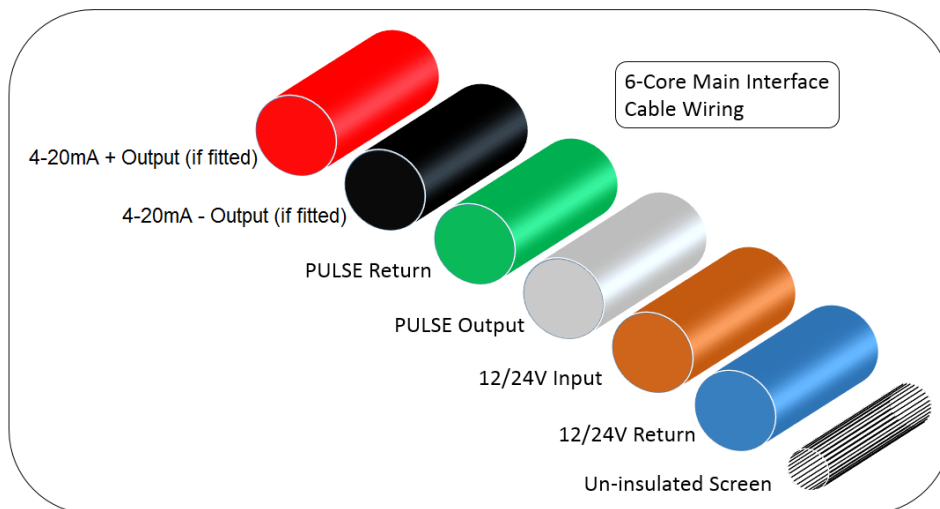

**Figure 6 : Cable Wiring Assignment**

The un-insulated wire is the connection to the screen of the cable and should be earthed for full immunity to electrical noise.

### 2.2.2 Pulse Output Connection



The isolated pulse output is provided by a SPNO/SPNC MOSFET relay which has a maximum load current of 500 mA and maximum load voltage of 24 V AC/DC.

This output is suitable for SELV circuits only.

Electrically this is a Volt, or potential free contact and, when selected as a low flow alarm, is configurable NO/NC.

### 2.2.3 Current Output

The isolated 4–20mA is a current source and can drive into a maximum load of 620Ω.



The alarm current due to a flow outside the range specified or due to a loss of signal is set at 3.5 mA.











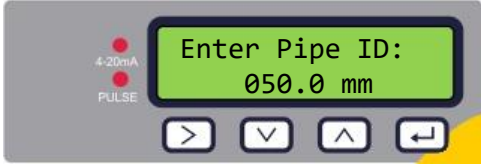

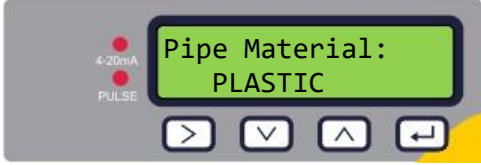

This output is suitable for SELV circuits only.

## 2.3 Switch On

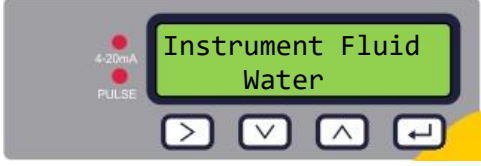
The initial screen sequence is different for the FM and HM models.

### 2.3.1 U1000mkII-FM

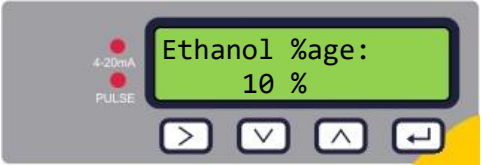
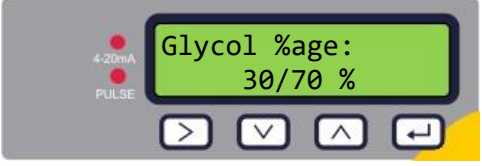
Switch on the power to the Electronics Module. A Micronics start-up screen is displayed for 5 seconds followed by hardware and software version information.

	<p>You are then prompted to enter the internal diameter of the pipe: Use the ,  and  keys to change the value. Press  to confirm the value.</p>
	<p>Select the pipe material by using the  and  keys to scroll through the list. Press  to confirm the material.</p>
	<p>Select the fluid using  and  to select <b>Water</b>, <b>Glycol</b> or <b>Ethanol</b> Press  to confirm the fluid name. Next for <b>Water</b> enter the <b>HOT / COLD</b> Option With <b>Glycol</b> or <b>Ethanol</b> enter the %age Mix then the actual Temperature</p>
	<p>Either Select the %age of <b>Ethanol</b>.</p>
	<p>Or Select the %age mix of <b>Glycol</b>.</p>
	<p>For <b>Glycol</b> and <b>Ethanol</b>, an actual Temperature is entered for sub 0 °C. Allowed range: -20.0–140.0 °C (-4.0–284.0 °F).</p>
	<p>For <b>Water</b> the Temperature range is entered For a temperature of &lt;= 40.0 °C select “COLD”. For a temperature of &gt; 40.0 °C select “HOT”.</p>

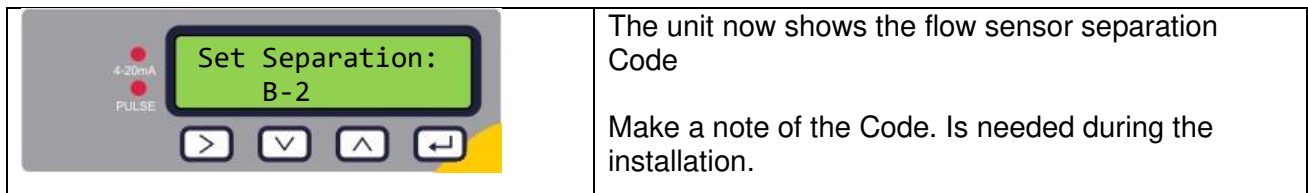

















All subsequent start-ups will use the same configuration.

Continue with the installation of the Sensor Assembly (see page 12).

2.3.2 UI000MKII-HM

Switch on the power to the Electronics Module. A Micronics start-up screen is displayed for 5 seconds followed by hardware and software version information.

	<p>You are then prompted to enter the internal diameter of the pipe: Use the ,  and  keys to change the value. Press  to confirm the value.</p>
	<p>Select the pipe material by using the  and  keys to scroll through the list. Press  to confirm the material.</p>
	<p>Select the Instrument Type using . The unit is preconfigured for Heating applications. Press  to confirm the setting.</p>
	<p>Select the Instrument Side (where flow sensors are installed) using . The unit is preconfigured for Flow. Press  to confirm the setting.</p>
	<p>Select the fluid using  and  to select <b>Water</b>, <b>Glycol</b> or <b>Ethanol</b>. Press  to confirm. Next for Water enter the <b>HOT / COLD</b> Option With <b>Glycol or Ethanol</b> enter the %age Mix then the actual Temperature</p>
	<p>Either Select the %age of <b>Ethanol</b>.</p>
	<p>Or Select the %age mix of <b>Glycol</b>.</p>
	<p>For <b>Glycol</b> and <b>Ethanol</b>, Set an actual Temperature sub 0 °C may be needed. Allowed range: -20.0–140.0 °C (-4.0–284.0 °F).  to accept and move to Set Separation Menu</p>

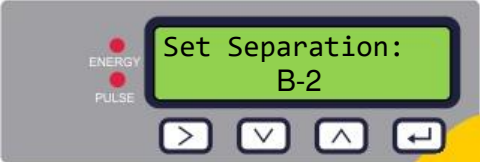
 <p>The screenshot shows a green LCD display with the text "Temperature: HOT   COLD". Above the display are two red LEDs labeled "ENERGY" and "PULSE". Below the display are four buttons: a right arrow, a down arrow, an up arrow, and a left arrow with a return symbol.</p>	<p>For <b>Water</b> the Temperature range is entered                  For a temperature of <math>\leq 40.0</math> °C select "COLD".                  For a temperature of <math>&gt; 40.0</math> °C select "HOT".</p>
 <p>The screenshot shows a green LCD display with the text "Set Separation: B-2". Above the display are two red LEDs labeled "ENERGY" and "PULSE". Below the display are four buttons: a right arrow, a down arrow, an up arrow, and a left arrow with a return symbol.</p>	<p>The unit now shows the correct flow sensor separation (in this case, "<b>B-2</b>") for the chosen values of pipe ID, pipe material and fluid.                   Make a note of the separation code.</p>

All subsequent start-ups will use the same configuration

Continue with the installation of the Sensor Assembly (see page 12).

## 2.4 Adjust Flow Sensor Separation

Using the separation code displayed by the Electronics Module, take the Sensor Assembly and adjust the flow sensor separation accordingly:

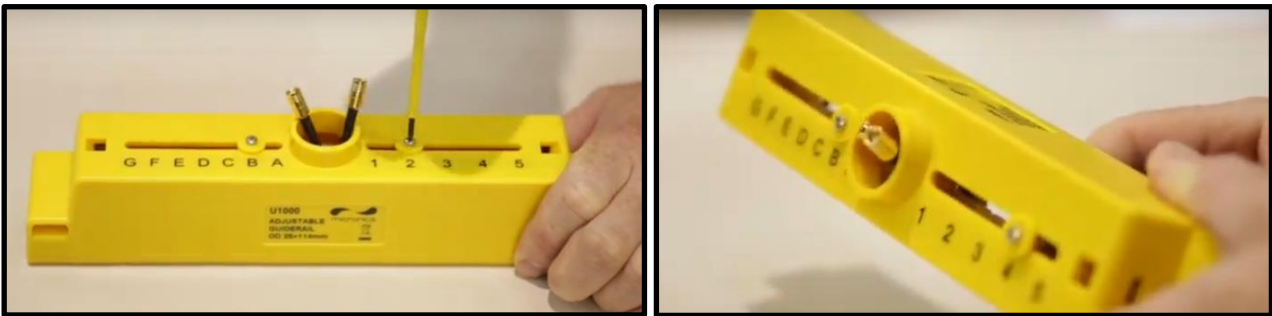

1. Adjust the screws on the flow sensors as to allow sideways movement. **DO NOT** fully unfasten or remove the screws at this stage.
2. Slide the flow sensors to the positions indicated on the display.
3. With the flow sensors in the correct positions, tighten the sensor-holding screws so that the sensors are fully recessed into the guiderail.

## 2.5 Apply Gel Pads

1. Apply a gel pad centrally onto the bases of each of the two flow sensors.
2. **Remove the covers from the gel pads.**
3. Ensure there are no air bubbles between each pad and sensor base.



## 2.6 Clamp Sensor Assembly to Pipe

The next step involves clamping the Sensor Assembly onto the pipe. Ensure that you have selected a suitable location and that the pipe is clean. If you are installing the unit on a pipe with an outside diameter less than 60mm use one or more of the adaptors supplied with the unit.



### 2.6.1 Pipe Adaptors

The diagrams below show how the adaptors are fitted. The top 'V' shaped adaptor clips onto the ends of the Sensor Assembly and this should be used with all pipes with an outside diameter less than 60 mm.

Additionally, for pipes with an outside diameter less than 40 mm, a second adaptor should also be used. This fits underneath the pipe as shown below.

**Important: Do not use these adaptors if the pipe has an outside diameter greater than 60 mm.**

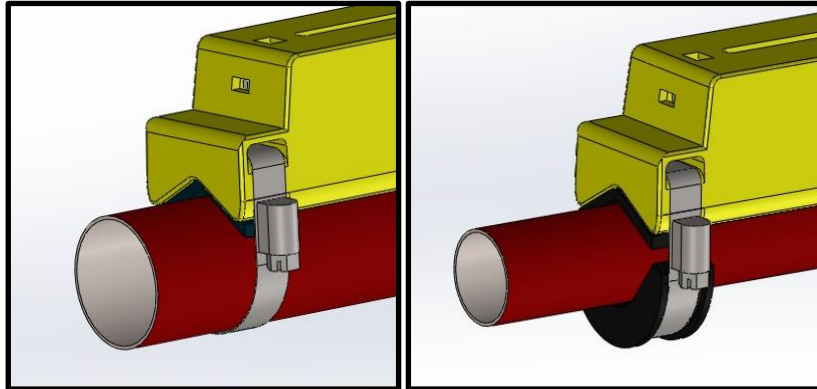

### 2.6.2 Attaching to Pipe

1. For pipes with an outside diameter less than 60 mm, attach the black clips to the bottom of the Sensor Assembly as shown below.



2. Place the Sensor Assembly on pipe.
3. For pipes with an outside diameter less than 40 mm, position the curved adaptor under the pipe.

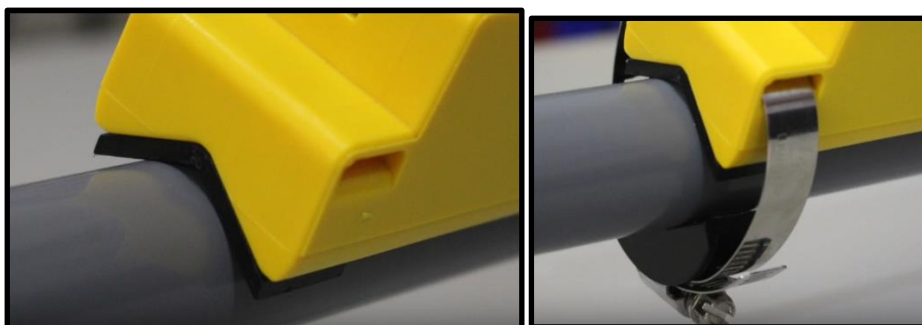

- Using the hose clips provided, clamp the Sensor Assembly (and adaptors, if used) to the pipe at an angle of 45° to the top of the pipe. Experience has shown that the most consistently accurate results are achieved when the unit is mounted at this angle. This minimises the effect of any flow turbulence resulting from entrained air along the top of the pipe and sludge at the bottom.

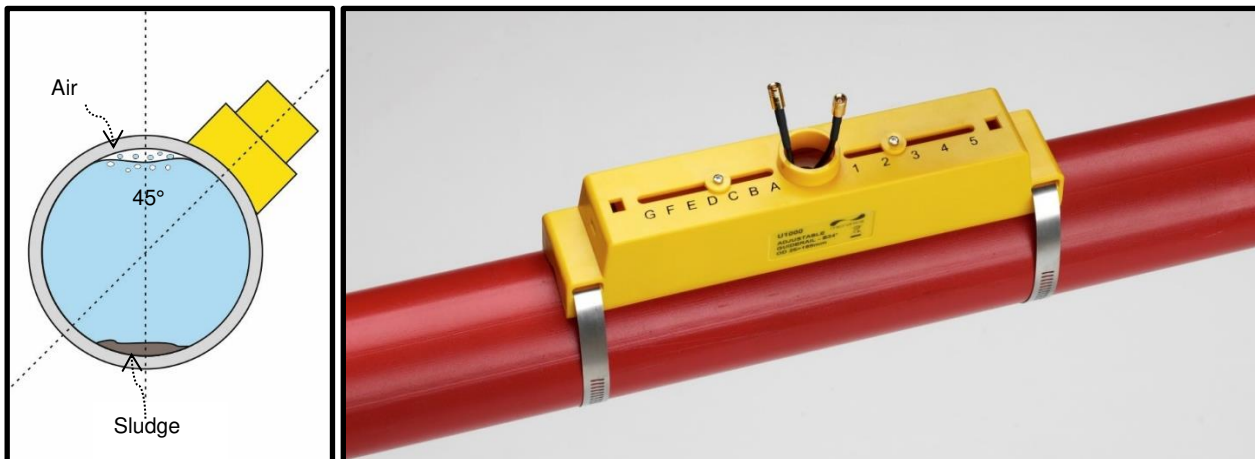

## 2.7 Remove Sensor-Holding Screws

Release and remove the sensor-holding screws. The flow sensors are spring-loaded to ensure good contact with the pipe surface.

**Note:** The sensor-holding screws and washers should be kept in a safe place in case it is necessary to relocate the unit.



## 2.8 Connect Electronics Module

1. Ensure that the power is switched off.
2. Connect the Electronics Module. The two leads can be connected either way round. The SMB connections are fragile so be careful when installing not to snap them off.



## 2.9 Attach the Temperature Sensors (U1000MKII-HM Only)

**Important: The temperature sensors must be balanced before initial use, using the procedure described below and used with the cable length supplied. Extending or shortening the cables will negate the calibration of the sensors.**

The area of pipe where the probes are to be attached must be free of grease and any insulating material. It is recommended that a thermal compound is used with the sensor, so it has the best possible thermal contact with the pipe. Lagging should also be placed over the sensor to remove the possibility of environmental factors affecting the reading

The sockets on the Electronics Module are marked **Cold** and **Hot**. This defines the location of the temperature sensors on installations where heat is being extracted from the system.



### 2.9.1 To ensure an accurate temperature differential:

1. Plug the temperature sensors into the Electronics Module and place them touching each other for 1 minute.

**DO NOT HOLD HT EPROBES TOGETHR WITH YOUR HAND.**

2. Enter the password-controlled menu and scroll to the *Calibration* sub-menu.
3. Press the Enter key until the *Zero Temp Offset* screen is displayed.
4. Select **Yes** and press the Enter key to display the *Attach Sensors* screen.
5. Press the Enter key again and wait for instrument to return to the *Zero Temp Offset* screen.
6. Switch off the power to the Electronics Module.
7. Complete the installation of the temperature sensors. The temperature sensors have a cut out profile to locate them; they are then anchored using the supplied cable ties. The cable ties should not be over tightened, or the sensors may be damaged. If the sensors are located under pipe-lagging, then ensure this does not put a strain on the sensor cables.
8. Tie down the sensor cables.

## 2.10 Clip Electronics Module to Sensor Assembly

If the unit is working correctly, clip the Electronics Module onto the Sensor Assembly. Secure in place with the screw on the right side.

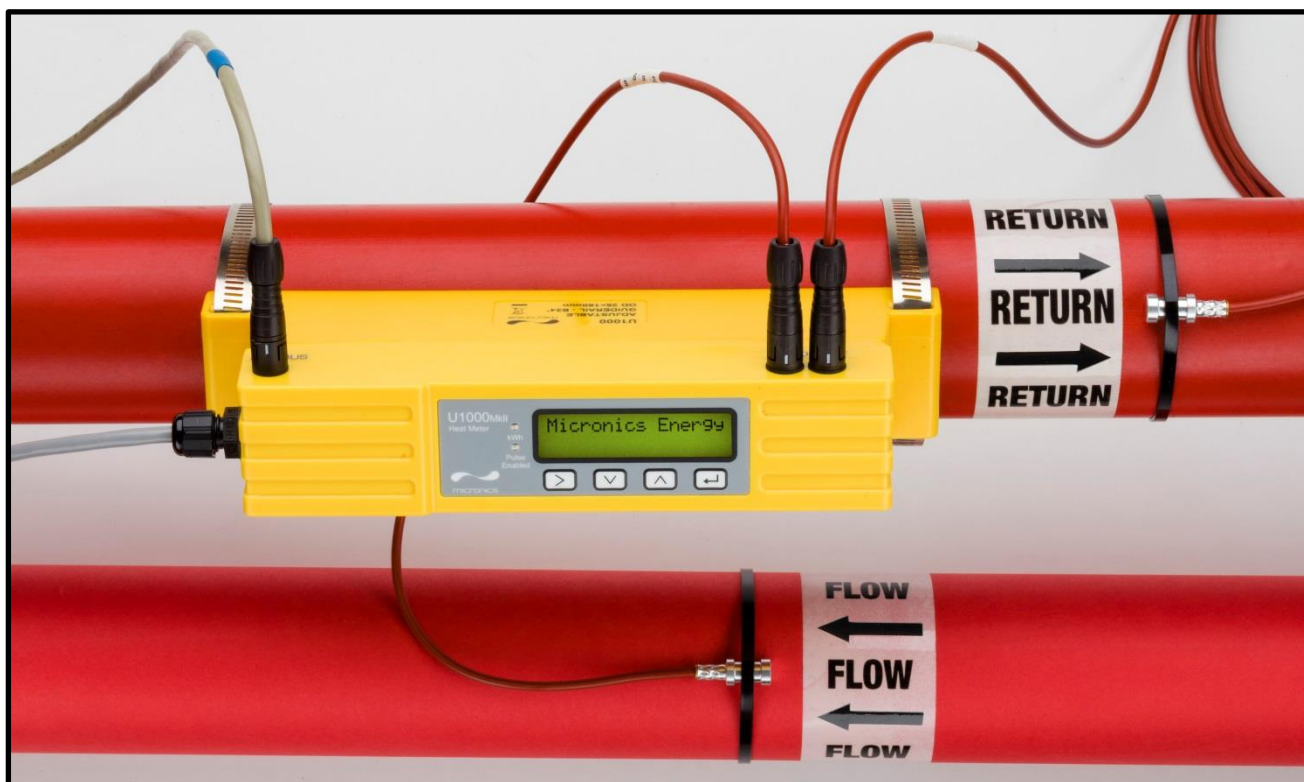

Figure 7 : Attach Electronics Module

## 2.11 Setting Zero Flow

To obtain accurate readings from the installation the flow sensors must be zeroed in their installed application. This will mean that the meter is reading accurately from a known set point

**Note: The fluid in the pipe must be in a stationary condition, if there is flow running in the pipe and the zero flow is set it will either result in an error if the flow is high enough or it will zero out the current flow value.**

### 3 MENU STRUCTURES

The password-protected menus allow you to change the default settings:

#### 3.1 Accessing the Menus

Ensure that the instrument is in *Flow Reading*, *Total Flow*, *Temperature dT*, *Total Energy*, *Instant Power* or *Total Flow* modes, then press .



Sig:87% \*  
246.3 l/min

Enter 71360 and then press .

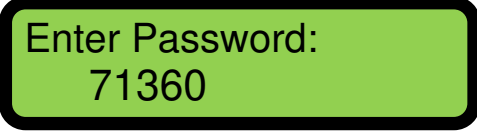



Enter Password:  
71360

The Setup Menu is displayed.



User Menu:  
Setup



Use  and  to cycle through the menu sections.

Press  to open a menu.

To return to the Flow Reading screen, scroll to **Exit** and press .



User Menu:  
Exit

Within a menu, press  to change between two displayed options (the active setting flashes) or, if there are several options, use  and  to cycle through the possible values.

Press  to confirm a value and display the next setting (or exit the menu if it is the last option).

### 3.2 Setup Menu Metric

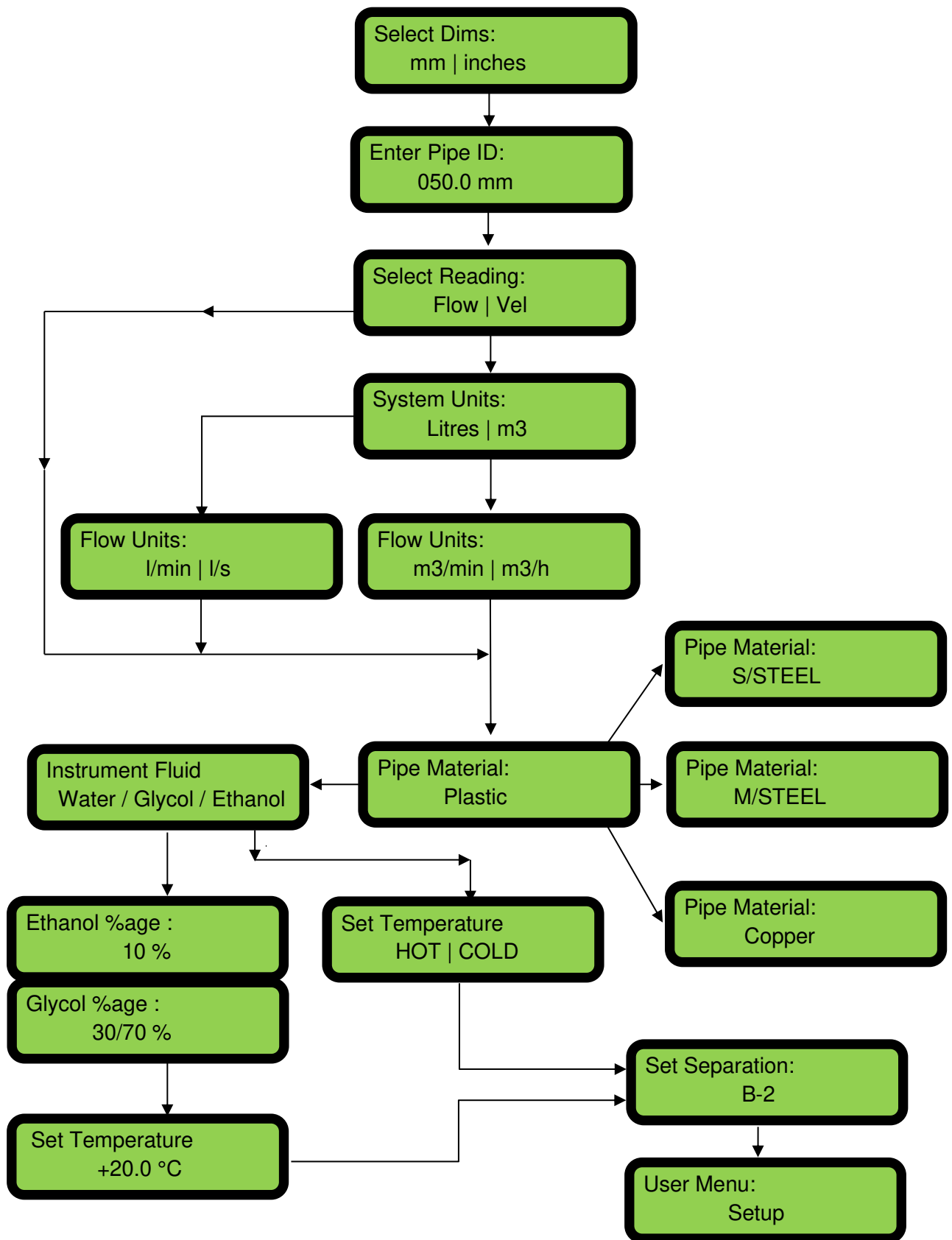

### 3.3 Setup Menu Imperial

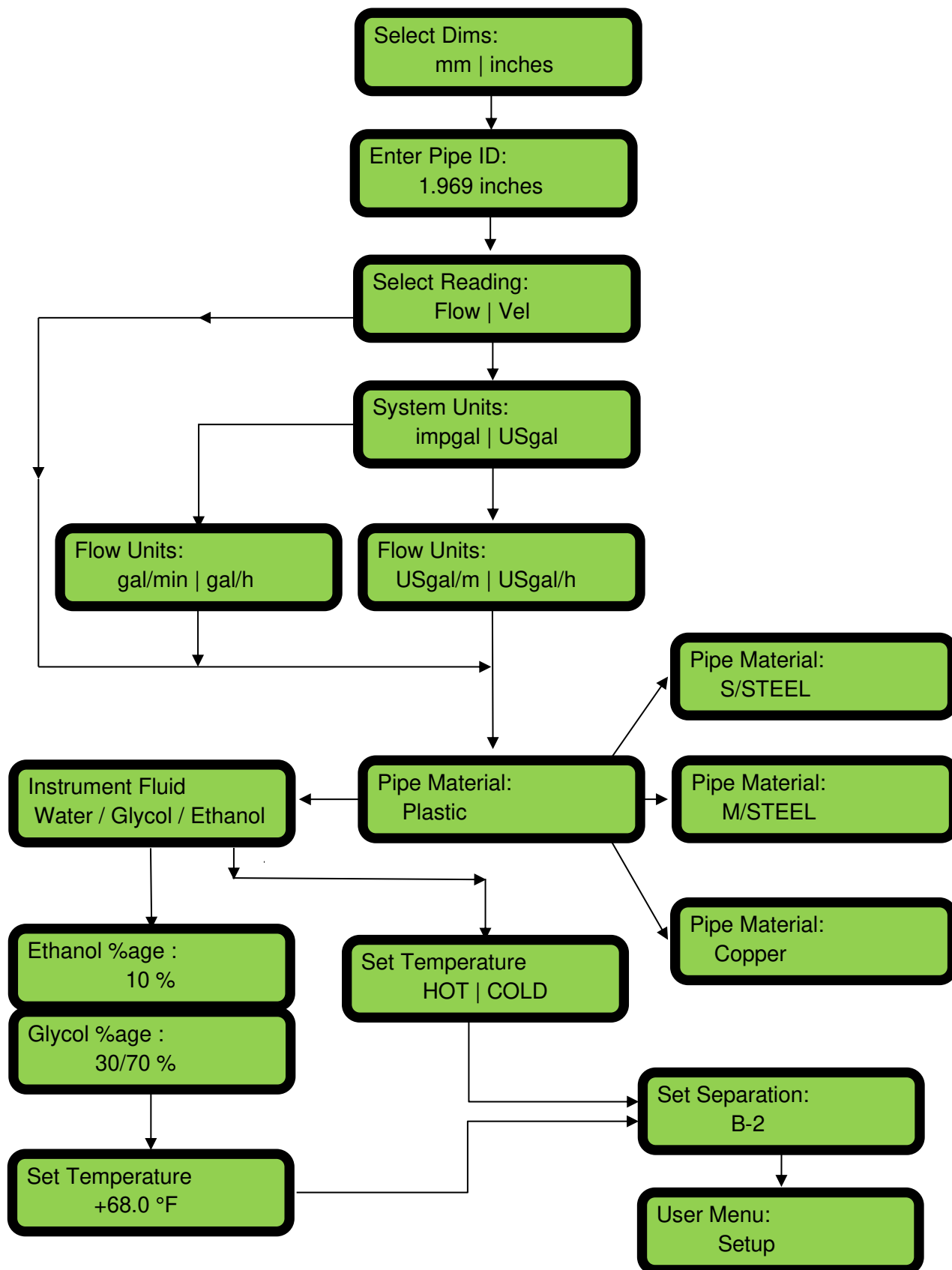



### 3.4 Volume Total Menu

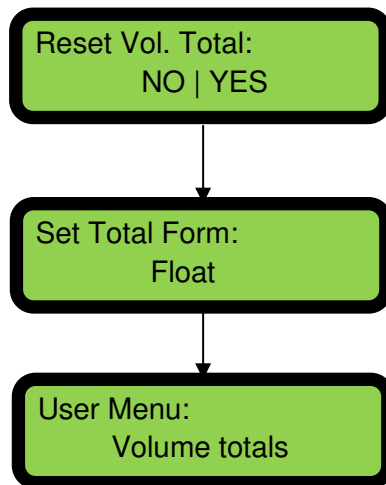

### 3.5 Current Output Menu

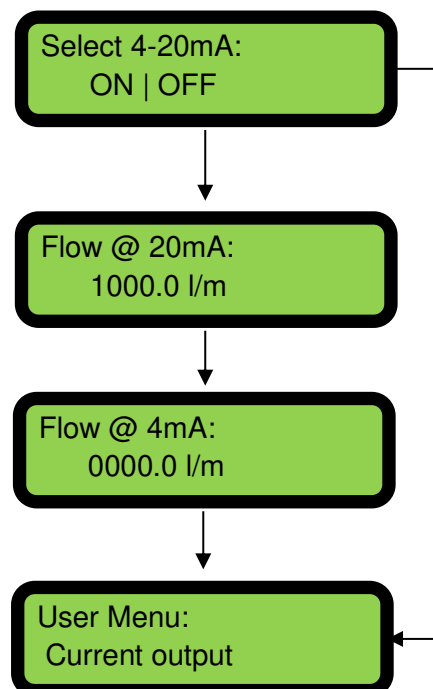

### 3.6 Pulse Output Menu

NOTE: SCREENS WITHIN THE RED BOX ARE ONLY SHOWN ON U1000MKII-HM MODELS.

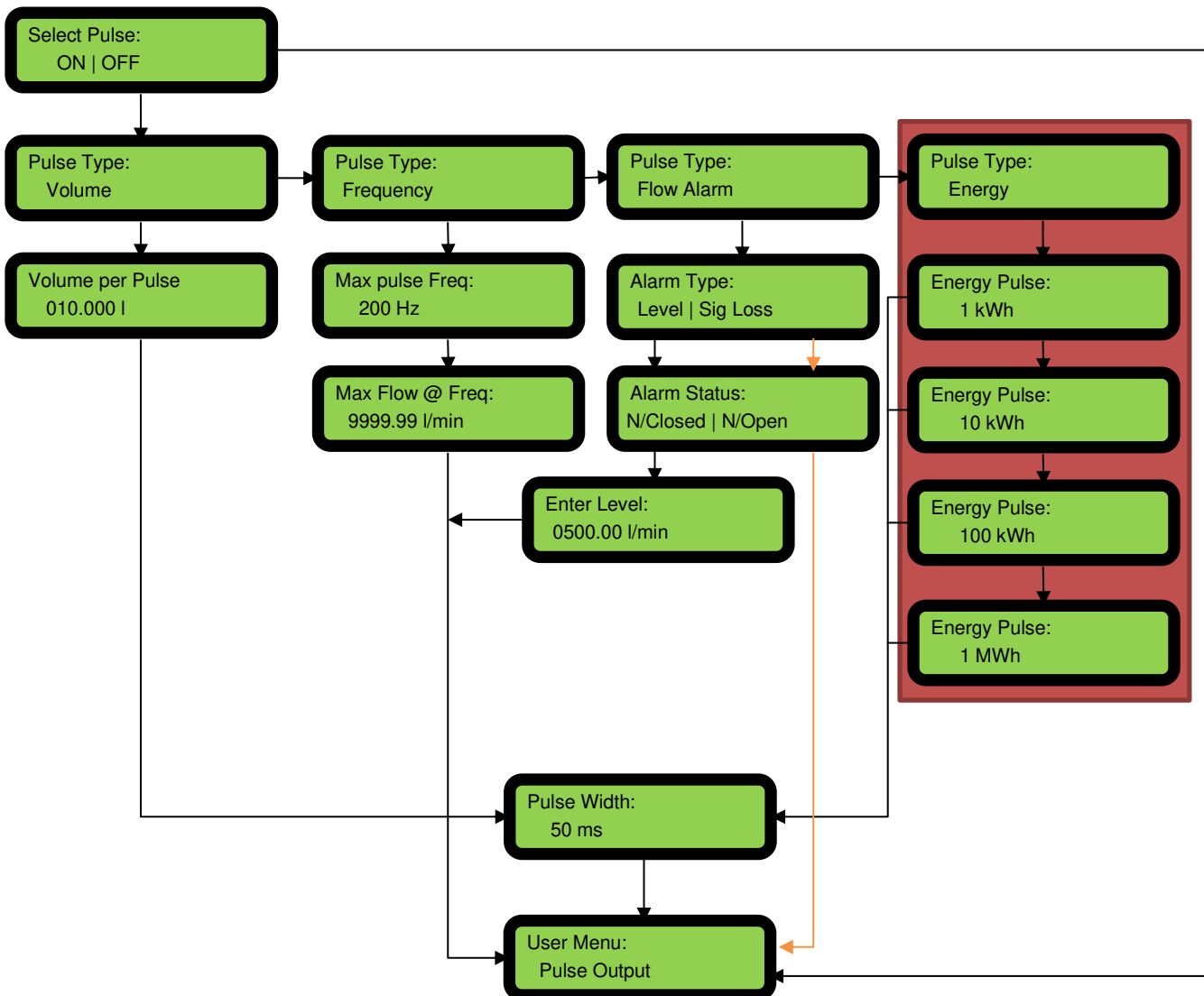



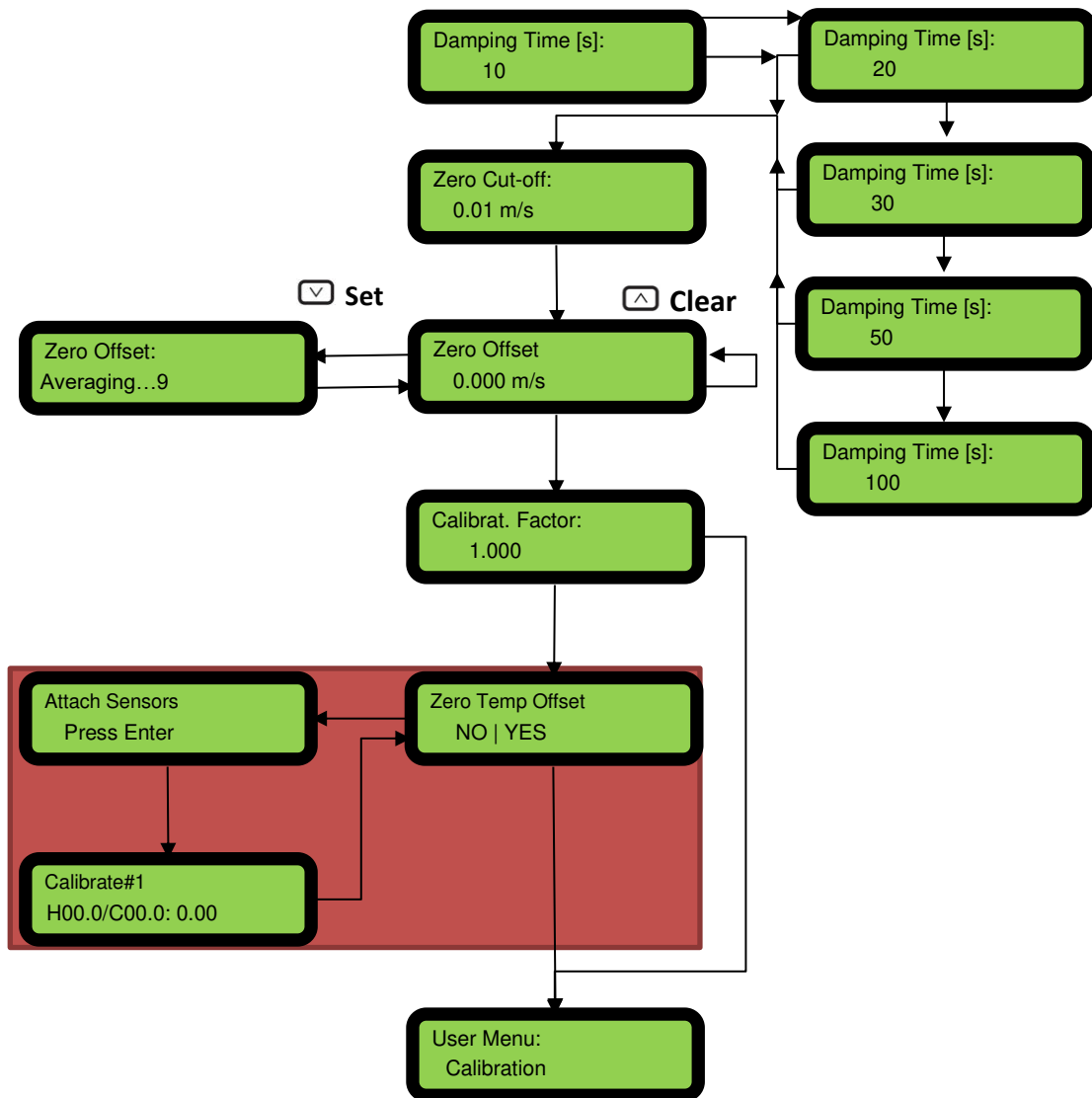

### 3.7 Calibration Menu

Note: Screens within the red box are only shown on U1000mkII-HM models.



### 3.8 Diagnostics Menu

The diagnostics menu provides some additional information about the flowmeter and its setup. The menu can be accessed by pressing the  key from the main flow-reading screen. Press the  and  keys to move between the diagnostics screens.

Press  to exit the Diagnostics menu.

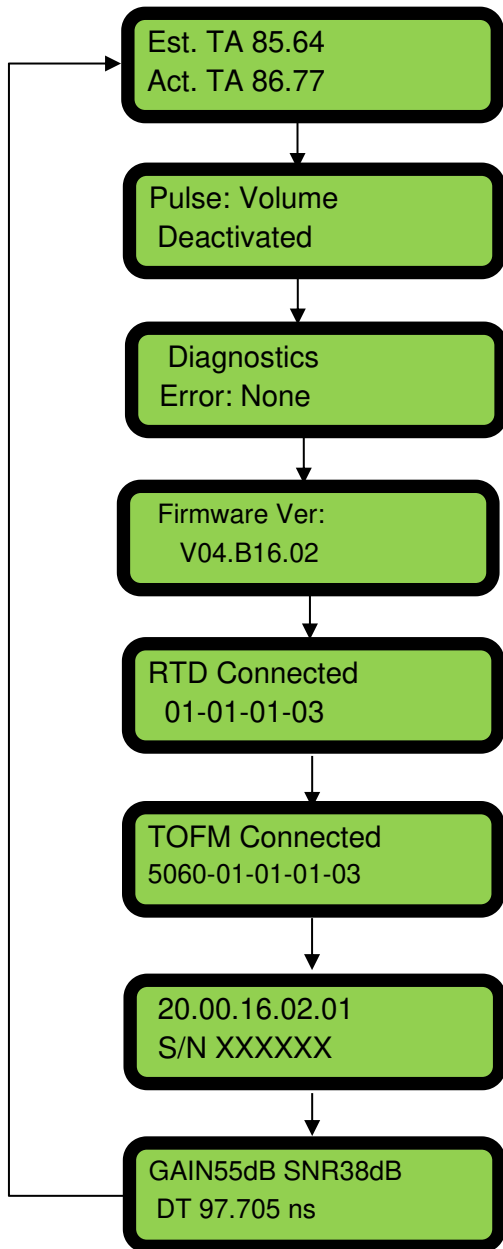

The Estimated TA (Time of Arrival) and Actual TA show the theoretical and measured transit times. If the actual value is displayed as 9999.99 then a usable signal could not be detected.

Displays the pulse status (for example): Deactivated, Volume 0.000 litres, Signal Loss, Alarm (On) 500.0 l/min, Alarm(Off) Signal Loss, Frequency 100.00 Hz.

This screen will display the Errors. A number between 1–255 will be displayed. If no errors reported “None” is displayed.

Firmware Version.

The RTD board’s software version is shown on the lower line. The upper line shows its status.

The flow board’s software version is shown on the upper line. The lower line shows its status.

The unit’s software version is shown on the upper line. The lower line shows the unit’s serial number.

Gain – a decibel number between -5 dB and 80 dB – *lower is better*, should be around 50 dB or below. Above 60 dB need to question the installation.

## 4 OUTPUTS

### 4.1 Pulse Output

Pulse output can be set up to operate one of five modes:

- Volumetric
- Energy (U1000MkII-HM only)
- Frequency
- Low Flow Alarm
- Loss of Flow (Signal) Alarm

The Alarm functions allow you to set the alarm switch to *Normally Open* or *Normally Closed*.

#### 4.1.1 Volumetric Pulse

The U1000MKII default pulse width is set to 50ms which represents half of one pulse cycle. A 50ms pulse width is required for most mechanical counters.

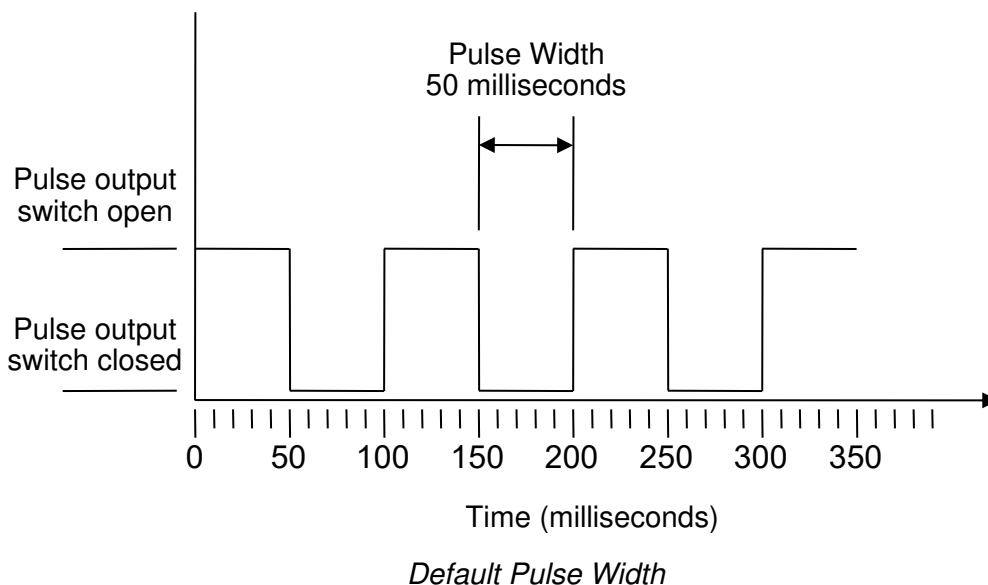

Formula to obtain Volume per Pulse based on a (default) 50ms pulse width:  
 Volume per Pulse  $\geq$  maximum flow rate (in litres per minute) / 600

Example for maximum flow rate of 500 l/min:  
 Volume per Pulse  $\geq$  500 l/min / 600 = 0.833 litres per pulse  
 Rounding up to nearest whole litre:  
 Set **Volume per Pulse** to **1 litre**.

#### 4.1.2 Frequency Mode

In Frequency mode, the output frequency is proportional to the flow rate within a specified frequency range of 1–200 Hz.

### 4.1.3 Energy Pulse (U1000MkII-HM only)

When the Pulse Output is set to Energy, the kWh LED will be permanently illuminated.

Choose from 1,10,100 kWh or 1 MWh when in metric mode and 1,10,100 kBTU or 1 MBTU in imperial mode.

Each pulse represents an amount of energy e.g. 1 kWh. The same limitation on maximum pulse rate applies as detailed in the Volumetric Mode. Again, a larger unit of energy per pulse or a smaller pulse width may be required.

### 4.1.4 Flow Alarm - Low Flow

For the Low Alarm the user can set a range between 0 and 9999 (no decimal places), in the same units being used to measure flow.

The default setting is normally open, but the user can select between N/O and N/C.

There is a 2.5% hysteresis on the switching of the output. Once the low flow alarm is activated, the flow rate must rise by 2.5% more than the set value to deactivate the alarm again.

### 4.1.5 Flow Alarm - Signal Loss

If the flow reading (signal) is lost, as indicated by the flow rate being displayed as “-----“, the alarm will be triggered. The default setting is normally open, but the user can select between N/O and N/C.

## 4.2 4–20 mA Current Output

The default 4–20mA output setting is OFF, and the 4–20mA LED on the keypad will not be illuminated. The default flow for 4mA is 0. This can be changed.

If the flow reading is greater than that set as the 20 mA value, or there is negative flow, or no flow signal can be detected, then an alarm current of 3.5 mA will generated.

**Note: The 4–20 mA current output is factory calibrated.**

## 5 CALIBRATION

Where the unit is factory calibration checked for compliance, the installation should also be verified by means of a calibrated reference meter and the unit calibration adapted to match should it be required.

## 6 RELOCATING THE UNIT

If it is necessary to relocate the unit use the following procedure:

1. Disconnect the temperature sensors (U1000MkII-HM only) and MODBUS cable (if used).
2. Unfasten hose clips and remove the complete unit from the pipe.
3. Undo the screw at the end of the Sensor Assembly and gently lift the same end of the Electronics Module as shown below.
4. The opposite end of the Electronics Module can now be released from the Sensor Assembly.



5. Disconnect the two wires connecting the Sensor Assembly and Electronics Module.
6. Remove the original gel pads from the two sensors.
7. Push the sensor blocks into the Sensor Assembly so that the washers and locking screws can be refitted.
8. Place replacement gel pads on the base of the sensors.
9. Follow the procedure for re-installing the unit on the pipe.
10. Redo the zero-offset if possible. If not ensure it is cleared.



## 7 TROUBLESHOOTING THE INSTALLATION

The direction of flow when powered up will be taken to be the positive flow direction. The pulse output will relate to the flow in this direction. If the flow is reversed, then the flow rate will still be displayed but the activity indication will change from an asterisk to an exclamation mark and no pulses will be generated.

Check the signal quality on the main Flow screen. Check the gain and signal to noise ratio (SNR) in the diagnostics menu. These should be sensible values. If not it is likely the sensors are poorly fitted.

If the flow value is displayed as "-----" this indicates that there is no usable signal from the flow sensors.

General poor/inconstant/or no readings are caused by the following:

### 7.1 Incorrect pipe data

Ensure that the correct inside diameter of the pipe is entered into the configuration. This can result in an incorrect separation distance.

### 7.2 Sensor not in contact with the pipe

Ensure that the coverings from the gel pads have been removed and that the sensors are located on the pipe with the setting screws fully removed.

### 7.3 Air in the liquid/pipe

If there is an excessive amount of air in the system or if the pipe is empty, there will be insufficient conditions for the meter to operate.

### 7.4 No Gel pad or grease on the sensor

Ensure that there is enough ultrasonic grease or that the Gel pads are installed on the sensor block in the correct location.

### 7.5 Very poor pipe condition-surface/inside

If the pipe surface is especially corroded or there is a possibility of there being deposits on the inside of the pipe the meter will fail to operate correctly. This will be the result of the roughness of the surface distorting the signals or an unknown thickness of a different property of material from the expected reading.

### 7.6 Positioning

For accurate measurements, the U1000MKII-FM/U1000MKII-HM must be installed at a position where the fluid flows uniformly. Flow profile distortions can result from upstream disturbance such as bends, tees, valves, pumps and other similar obstructions. To ensure a uniform flow profile, the unit must be mounted away from any cause of flow disturbance.

As a guide, we suggest this is best achieved by ensuring there is a straight length of pipe upstream of the transducers of at least 10 times the pipe diameter, and 5 times the pipe diameter on the downstream side, as shown in Figure 3, but this may vary. Flow Measurements can be made on shorter lengths of straight pipe, but when the transducers are mounted this close to any obstruction the resulting errors can be unpredictable.

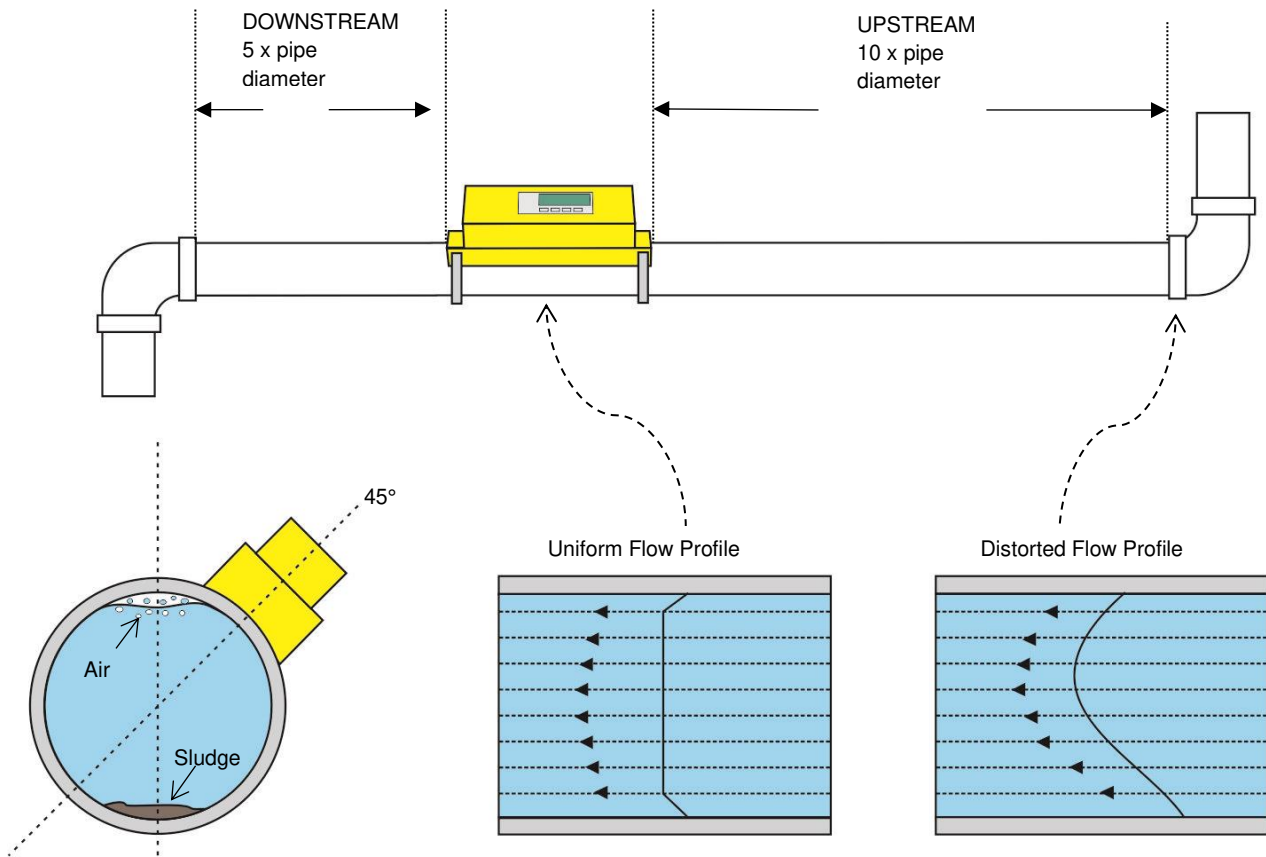

**Figure 8 : Sensor Positioning**

To obtain the most accurate results, the condition of both the liquid and the pipe must be suitable to allow ultrasound transmission along the predetermined path.

In many applications, an even flow velocity profile over a full 360° is unattainable due, for example, to the presence of air turbulence at the top of the flow and possibly sludge at the bottom of the pipe. Experience has shown that the most consistently accurate results are achieved when the sensors are mounted at 45° with respect to the top of the pipe. In chiller applications, the U1000MKII sensor/electronics must be mounted at 45° with respect to the top of the pipe to prevent condensation entering the electronics unit.

**Important: Do not expect to obtain accurate results if the unit is positioned close to any obstruction that distorts the uniformity of the flow profile. Micronics Ltd accepts no responsibility or liability if product has not been installed in accordance with these instructions.**

## 7.7 Flow reading when the system is closed

Often the cause of seeing a flow rate when the system is isolated, or the pump is off is that the sensors weren't set with a zero-flow offset when installed. [See Section Setting Zero flow.](#)

## 7.8 No flow reading visible when the system is active

In installations where there is a low flow rate it will show as the instrument is not reading any flow, this can be remedied by lowering or removing the zero cut-off.

It is worth noting that if the cut-off is lowered beyond the factory setting that the unit may show a flow rate on the display when there isn't one, setting the zero flow can help to alleviate this but noise or temperature instability can affect the reading. [See section Calibration menu](#)

## 7.9 Limitations with galvanised pipe

If the meter is to be installed on a galvanised pipe it should be noted that the surface roughness can affect the flow accuracy and in some instances the meter will be unable to obtain a valid flow signal.

## 7.10 Limitations with Mixtures

For different systems the exact mix of the components can be an uncontrolled variable. The speed of sound varies with concentration and can produce errors, or loss of accuracy.

### 7.10.1 Glycol / Water mixes

It is assumed that Ethylene Glycol is used, and not other possible variants e.g., Propylene Glycol.

With water glycol mixes it may be difficult to know the true percentage of Glycol in a system. This is estimated by the end user and will be correct at some point but may vary as fluid levels are topped-up.

### 7.10.2 Ethanol Water mixes

With ethanol mixes, again, the concentration may not be known accurately.

### 7.10.3 Additives

For water, water/glycol and water/ethanol mixes, the presence of additives, typically to stop corrosion, is an unknown factor. Again this can vary as levels are topped-up.

## 7.11 Limitations with composite pipes

Testing has show that there is limited compatibility with the Micronics ultrasonic flowmeters when being used with a multi-layer composite pipe.

The construction of the pipe doesn't allow signals to propagate in the desired manner therefore the signals can either arrive in an unexpected location or the signal is so diminished that there is no information to process.

## 8 APPENDIX

### 8.1 Specification

General	
Measuring Technique	Transit time
Measurement channels	1
Timing Resolution	±50 ps
Turn down ratio	100:1
Flow velocity range	0.1 to 10 m/s
Applicable Fluid types	Clean water with < 3% by volume of particulate content, or up to 30% ethylene glycol.
Accuracy	±3% of flow reading for velocity rate >0.3 m/s
Repeatability	±0.15% of measured value
Pipe Ranges	25–115 mm OD and 125–180 mm OD Note: Pipe size is dependent on pipe material and internal diameter.
Selectable units for metric (mm)	Velocity: m/s Flow Rate: l/s, l/min, m <sup>3</sup> /min, m <sup>3</sup> /hr Volume : litres, m <sup>3</sup>
Selectable units for Imperial (inches)	Velocity: ft/s Flow rate: gal/min, gal/hr, USgal/min, USgal/hr Volume: gals, USgals
Totaliser	See section on Totals and rollover
Languages supported	English only
Power input	12–24 VDC or 24 VAC
Power consumption	7 W (DC) or 7 VA (AC) maximum
Cable	5 m screened 6 core
Pulse Output	
Output	Opto-isolated MOSFET volt free contact (NO/NC).
Isolation	1MΩ @ 100V
Pulse width	Default value 50ms; programmable range 3 – 99ms
Pulse repetition rate	Up to 166 pulses/sec (depending on pulse width)
Frequency mode	200 Hz maximum (Range 1–200)
Maximum load voltage/current	24V DC or 24V AC / 500mA
Current Output (if fitted)	
Output	4–20 mA
Resolution	0.1% of full scale
Maximum load	620Ω
Isolation	1 MΩ @ 100 V
Alarm current	3.5 mA

*continued on next page*

continued from previous page

<b>Modbus</b>	
<b>Format</b>	RTU
<b>Baud rate</b>	1200, 2400, 4800, 9600, 19200, 38400
<b>Data-Parity-StopBits</b>	8-None-2, 8-None-1, 8-Odd-2, 8-Even-1
<b>Standards</b>	PI-MBUS-300 Rev. J
<b>Physical connection</b>	RS485
<b>M-Bus</b>	
<b>Baud rates</b>	300, 2400 & 9600
<b>Data-Parity-StopBits</b>	8-Even-1
<b>Standards</b>	EN13757 / EN1434
<b>Temperature sensors</b>	<i>U1000MkII-HM only</i>
<b>Type</b>	PT100 Class B 4 wire
<b>Range</b>	2 to 85 °C (36 to 185 °F)
<b>Resolution</b>	0.1 °C / 1 °F
<b>Sensor Accuracy</b>	±0.725 °C (±1.305 °F)
<b>Enclosure</b>	
<b>Material</b>	Plastic Polycarbonate
<b>Fixing</b>	Pipe mountable
<b>Degree of Protection</b>	IP40 (Not verified by UL)
<b>Flammability Rating</b>	UL94 V-2/HB
<b>Dimensions</b>	250 mm x 48 mm x 90 mm (electronics module + sensor assembly)
<b>Weight</b>	0.5 kg
<b>Environmental</b>	
<b>Maximum Pipe temperature</b>	0 to 85 °C
<b>Operating temperature (Electronics)</b>	0 to 50 °C
<b>Storage temperature</b>	-10 °C to 60 °C
<b>Humidity</b>	90% RH at 50 °C Max
<b>Maximum altitude</b>	4,000 m
<b>Indoors/outdoors</b>	Indoors
<b>Wet locations</b>	A location in which water or other liquid can drip, splash, or flow on or against electrical equipment.
<b>Pollution degree</b>	3: Conductive pollution or dry nonconductive pollution that becomes conductive due to condensation.
<b>Display</b>	
<b>LCD</b>	2 line x 16 characters
<b>Viewing angle</b>	Min 30°
<b>Active area</b>	58 mm (W) x 11 mm(H)
<b>Keypad</b>	
<b>Format</b>	4 key tactile feedback membrane keypad



! Servicing or repairs to the unit can only be carried out by the manufacturer.

## 8.2 Default values

The settings will be configured at the factory for metric units. The following table lists the metric and imperial default values.

Parameter	Default Value	
	Metric	Imperial
<b>Dimensions</b>	mm	inches
<b>Flow Units</b>	l/min	USgal/min
<b>Pipe size (ID)</b>	1" to 4" pipes: 50 mm 4" to 6" pipes: 127 mm	1" to 4": 1.969 in 4" to 6" pipes: 5.000 in
<b>Pulse Output</b>	Off	Off
<b>Energy per Pulse</b> <i>(U1000MkII-HM only)</i>	1 kW	1 kBTU
<b>Volume per Pulse</b>	10 litres	2.642 US gallons
<b>Pulse Width</b>	50 ms	50 ms
<b>Damping</b>	20 seconds	20 seconds
<b>Calibration Factor</b>	1.000	1.000
<b>Zero Cut-off</b>	0.02 m/s	0.07 ft/s
<b>Zero Offset</b>	0.000 m/s	0.000 ft/s

### 8.2.1 Data Entry Errors

These generally advise you that the data entered is not within the specified range (Replace with Imperial units as needed):

Range 20.0–165.1  
0.000 mm

Displayed when an invalid Pipe ID is entered, prompting the user to enter a value between 20 and 165 mm, depending on the product purchased.

Calibrate Error  
Press Enter

An attempt has been made to zero the offset between the temperature sensors, and the difference in temperature is too large. Ensure the temperature sensors are correctly plugged in and are both at the same temperature.

Range 1 - 200  
200

When programming a Frequency Pulse output the frequency is limited to the range 1 to 200 Hz.

Range 3 - 99  
0000.0

When programming a Volume Pulse output the pulse width is limited to the range 3 to 99 ms.

Range 0.00-0.500  
0000.0

When programming the Zero Cut-off this is limited to the range 0.000 to 0.500.

Range 0.500-1.500  
0000.0

When programming the Calibration Factor this is limited to the range 0.5 to 1.5.